

SDRH 250 293 112 K 98 C X

ID 203664

Technisches Datenblatt
Technical data sheet











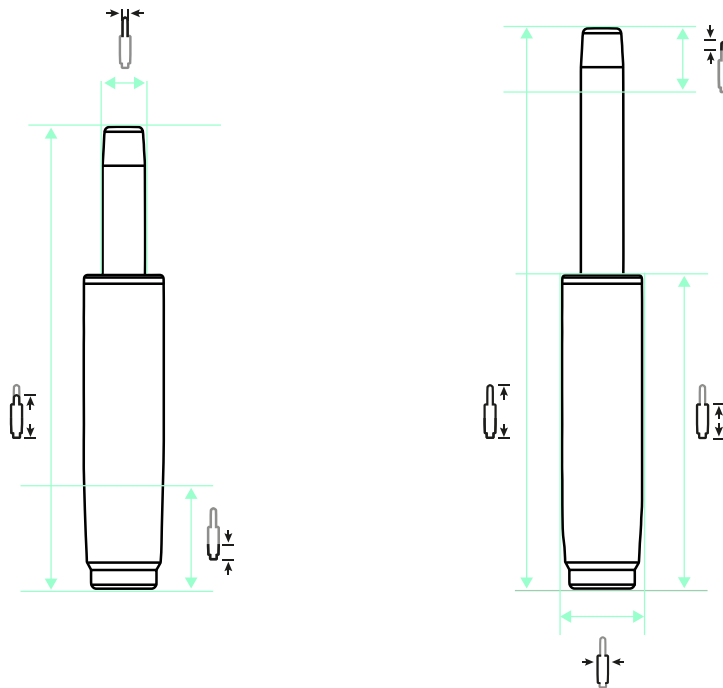

Spezifikationen Specifications

ID ID	203664	Hub Stroke	112 mm	Standrohrdurchmess Standpipe diameter	50 mm	Drehbar Rotatable	1
Matchcode Matchcode	SDRH250293112K9	Gewichtsgrenze Weight limit	140 kg	Aufbauhöhe ab Fuß M Build-up height from	195 mm		
Bezeichnung 1 Designation 1	SDRH 250 293 112 K	Klasse Class	4	Aufbauhöhe ab Fuß M Installation height fro	307 mm		
Artikelgruppe Article group	Revolving + Lifting	Durchmesser Gaseinl Diameter gas unit	28 mm	Material Material	Stahlblech		
Basismengeneinheit Base quantityunit	Stk	Konuslänge Gaseinhe Cone length gas unit	33 mm	Druck Pressure	320 N		
Gewicht Weight	1.09 kg	Konuslänge Cone length	98 mm	Anschraubbild Bolting pattern	-		
Farbe Colour	chrom	Gesamthöhe Höchste Total height Highest p	405 mm	Revolving Revolving	1		
Gesamthöhe niedrigs Total height lowest p	293 mm	Standrohrlänge Standpipe length	250 mm	Höhenverstellbar Heightadjustable	1		

SDRH 250 293 112 K 98 C X

ID 203664



 112 mm |
  405 mm |
  293 mm |
  250 mm |
  98 mm |
  33 mm |
  50 mm |
  28 mm |
  320 N

ZUBEHÖR ACCESSORIES



AD 38 / 50



AD 40 / 50



ÜS-Rohr 183



ÜS-Rohr 244



ÜS-Rohr 298

EMPFEHLUNGEN RECOMMENDATIONS



STELLAR 690 Middle 5 P



STELLAR 690 Middle 5 S



North 1 Alu-Mechanik P



Tendo P