

SDR 195 291 K 70 C X

ID 203854

Technisches Datenblatt
Technical data sheet









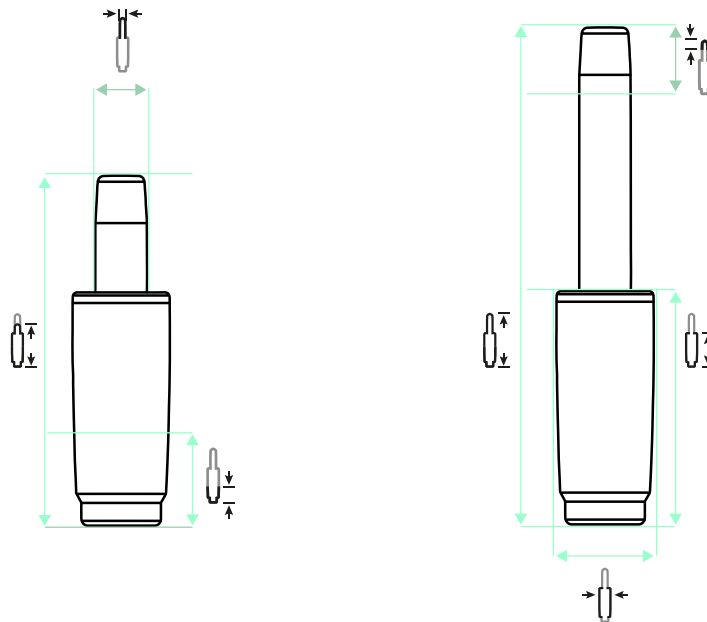

Spezifikationen Specifications

ID ID	203854	Gewichtsgrenze Weight limit	140 kg	Aufbauhöhe ab Fuß Min. Build-up height from foot	220 mm
Matchcode Matchcode	SDR195291K70CX	Klasse Class	4	Aufbauhöhe ab Fuß Max. Installation height from foot	220 mm
Bezeichnung 1 Designation 1	SDR 195 291 K 70 C X	Durchmesser Gaseinheit Diameter gas unit	28 mm	Material	Stahlblech
Artikelgruppe Article group	Revolving	Konuslänge Gaseinheit Cone length gas unit	33 mm	Druck Pressure	N
Basismengeneinheit Base quantity unit	Stk	Konuslänge Cone length	70 mm	Anschraubbild Bolting pattern	-
Gewicht Weight	1.09 kg	Gesamthöhe Höchste Pos. Total height Highest position	291 mm	Revolving Revolving	1
Farbe Colour	chrom	Standrohrlänge Standpipe length	195 mm	Drehbar Rotatable	1
Gesamthöhe niedrigste Pos. Total height lowest position	291 mm	Standrohrdurchmesser Standpipe diameter	50 mm		

SDR 195 291 K 70 C X

ID 203854



 291 mm |
  291 mm |
  195 mm |
  70 mm |
  33 mm |
  50 mm |
  28 mm |
  N

ZUBEHÖR ACCESSORIES



AD 38 / 50



AD 40 / 50



ÜS-Rohr 183



ÜS-Rohr 244



ÜS-Rohr 298

EMPFEHLUNGEN RECOMMENDATIONS



STELLAR 690 Middle 5 P



STELLAR 690 Middle 5 S



North 1 Alu-Mechanik P



Tendo P