

# S 201 253 126 K 125 S X

ID 201904

Technisches Datenblatt  
Technical data sheet



## Spezifikationen Specifications

ID ID	201904	Farbe Colour	schwarz	Gesamthöhe Höchste Total height Highest p	379 mm	Drehbar Rotatable	1
Matchcode Matchcode	S200253126K125SX	Gesamthöhe niedrigs Total height lowest po	253 mm	Standrohrlänge Standpipe length	200 mm		
Bezeichnung 1 Designation 1	S 201 253 126 K 125	Hub Stroke	126 mm	Standrohrdurchmess Standpipe diameter	50 mm		
Artikelgruppe Article group	Standard Line Schw	Gewichtsgrenze Weight limit	140 kg	Aufbauhöhe ab Fuß M Build-up height from	128 mm		
Basismengeneinheit Base quantityunit	Stk	Klasse Class	4	Aufbauhöhe ab Fuß M Installation height fro	254 mm		
Menge Karton Quantity carton	20	Durchmesser Gaseinl Diameter gas unit	28 mm	Material	Stahlblech		
Menge Palette Quantity pallet	600	Konuslänge Gaseinhe Cone length gas unit	33 mm	Druck Pressure	320 N		
Gewicht Weight	1.027 kg	Konuslänge Cone length	125 mm	Höhenverstellbar Heightadjustable	1		

# S 201 253 126 K 125 S X

ID 201904

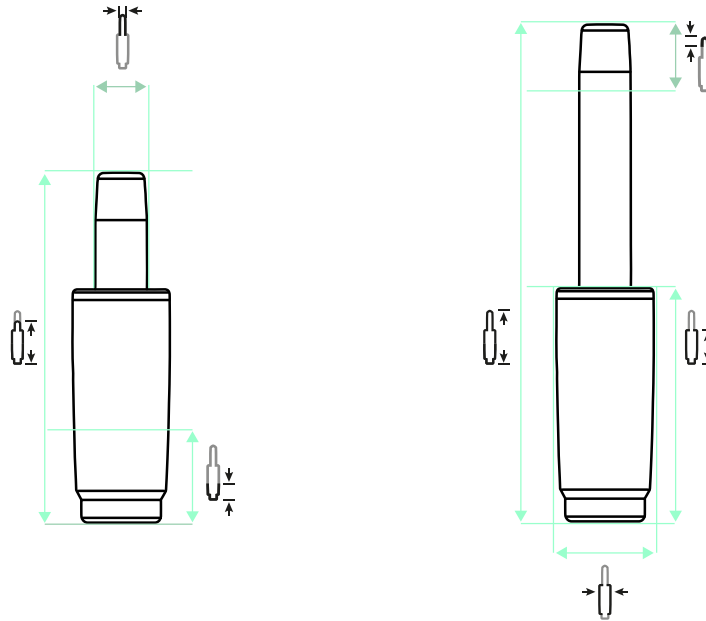

126 mm |
 379 mm |
 253 mm |
 200 mm |
 125 mm |
 33 mm |
 50 mm |
 28 mm |
 320 N

## ZUBEHÖR ACCESSORIES



AD 38 / 50



AD 40 / 50



ÜS-Rohr 183



ÜS-Rohr 244



ÜS-Rohr 298

## EMPFEHLUNGEN RECOMMENDATIONS



North 1 Alu-Mechanik P



Threesixty