

S 375 431 262 K 50 S X

ID 205888

Technisches Datenblatt
Technical data sheet



Spezifikationen Specifications

ID ID	205888	Farbe Colour	schwarz	Gesamthöhe Höchste Total height Highest p	693 mm	Drehbar Rotatable	1
Matchcode Matchcode	S375431262K50SX	Gesamthöhe niedrigs Total height lowest p	431 mm	Standrohrlänge Standpipe length	375 mm		
Bezeichnung 1 Designation 1	S 375 431 262 K 50	Hub Stroke	260 mm	Standrohrdurchmess Standpipe diameter	50 mm		
Artikelgruppe Article group	Standard Line Schw	Gewichtsgrenze Weight limit	140 kg	Aufbauhöhe ab Fuß M Build-up height from	373 mm		
Basismengeneinheit Base quantityunit	Stk	Klasse Class	4	Aufbauhöhe ab Fuß M Installation height fro	635 mm		
Menge Karton Quantity carton	10	Durchmesser Gaseinl Diameter gas unit	28 mm	Material	Stahlblech		
Menge Palette Quantity pallet	420	Konuslänge Gaseinhe Cone length gas unit	33 mm	Druck Pressure	320 N		
Gewicht Weight	1.805 kg	Konuslänge Cone length	58 mm	Höhenverstellbar Heightadjustable	1		

S 375 431 262 K 50 S X

ID 205888

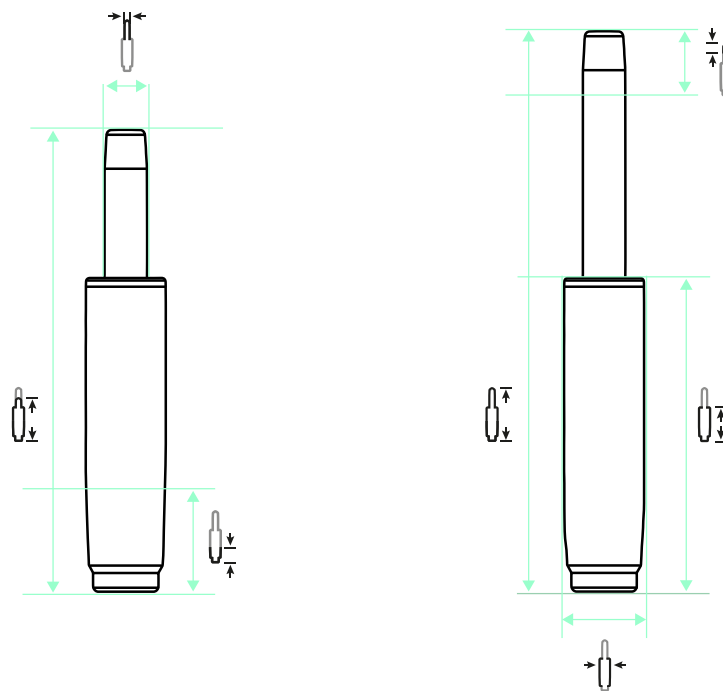

260 mm |
 693 mm |
 431 mm |
 375 mm |
 58 mm |
 33 mm |
 50 mm |
 28 mm |
 320 N

ZUBEHÖR ACCESSORIES



AD 38 / 50



AD 40 / 50



ÜS-Rohr 183



ÜS-Rohr 244



ÜS-Rohr 298

EMPFEHLUNGEN RECOMMENDATIONS



North 1 Alu-Mechanik P



Threesixty