

S 40 300 363 202 K 100 S X

ID 102537

Technisches Datenblatt
Technical data sheet



Spezifikationen Specifications

ID ID	102537	Gesamthöhe niedrigs Total height lowest p	363 mm	Standrohrlänge Standpipe length	300 mm	Drehbar Rotatable	1
Matchcode Matchcode	S40300363202K100	Hub Stroke	202 mm	Standrohrdurchmess Standpipe diameter	40 mm		
Bezeichnung 1 Designation 1	S 40 300 363 202 K	Gewichtsgrenze Weight limit	140 kg	Aufbauhöhe ab Fuß M Build-up height from	263 mm		
Artikelgruppe Article group	Thin Line 40mm	Klasse Class	4	Aufbauhöhe ab Fuß M Installation height fro	465 mm		
Basismengeneinheit Base quantityunit	Stk	Durchmesser Gaseinl Diameter gas unit	28 mm	Material Material	Stahlblech		
Menge Karton Quantity carton	12	Konuslänge Gaseinhe Cone length gas unit	33 mm	Druck Pressure	320 N		
Gewicht Weight	1.49 kg	Konuslänge Cone length	100 mm	Anschraubbild Bolting pattern	-		
Farbe Colour	schwarz	Gesamthöhe Höchste Total height Highest p	565 mm	Höhenverstellbar Heightadjustable	1		

S 40 300 363 202 K 100 S X

ID 102537

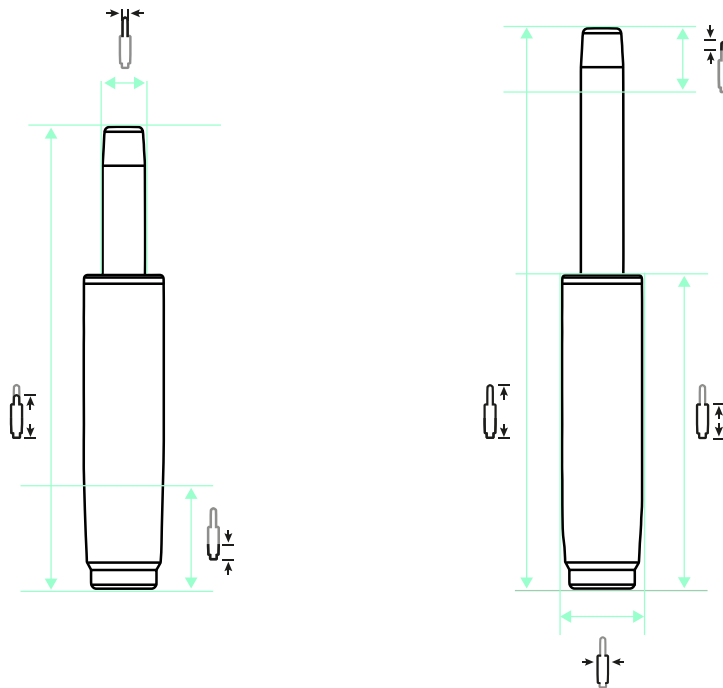

202 mm |
 565 mm |
 363 mm |
 300 mm |
 100 mm |
 33 mm |
 40 mm |
 28 mm |
 320 N

EMPFEHLUNGEN RECOMMENDATIONS



AF 294 K40 P



North 1 Alu-Mechanik P



Threesixty