

S 40 370 448 257 K 100 S X

ID 102538

Technisches Datenblatt
Technical data sheet



Spezifikationen Specifications

ID ID	102538	Gesamthöhe niedrigs Total height lowest p	448 mm	Standrohrlänge Standpipe length	370 mm	Drehbar Rotatable	1
Matchcode Matchcode	S40370448257K100	Hub Stroke	257 mm	Standrohrdurchmess Standpipe diameter	40 mm		
Bezeichnung 1 Designation 1	S 40 370 448 257 K	Gewichtsgrenze Weight limit	140 kg	Aufbauhöhe ab Fuß M Build-up height from	348 mm		
Artikelgruppe Article group	Thin Line 40mm	Klasse Class	4	Aufbauhöhe ab Fuß M Installation height fro	605 mm		
Basismengeneinheit Base quantityunit	Stk	Durchmesser Gaseinl Diameter gas unit	28 mm	Material Material	Stahlblech		
Menge Karton Quantity carton	10	Konuslänge Gaseinhe Cone length gas unit	33 mm	Druck Pressure	320 N		
Gewicht Weight	1.69 kg	Konuslänge Cone length	100 mm	Anschraubbild Bolting pattern	-		
Farbe Colour	schwarz	Gesamthöhe Höchste Total height Highest p	705 mm	Höhenverstellbar Heightadjustable	1		

S 40 370 448 257 K 100 S X

ID 102538

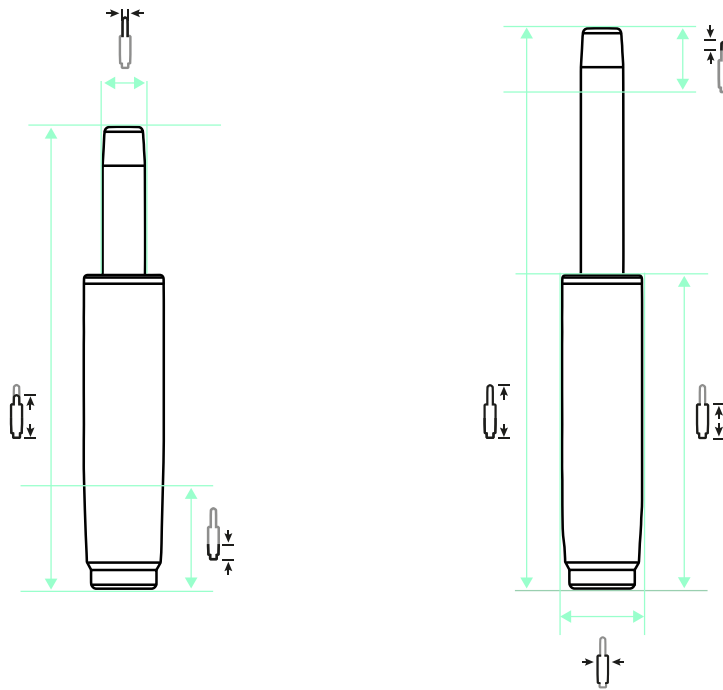

257 mm |
 705 mm |
 448 mm |
 370 mm |
 100 mm |
 33 mm |
 40 mm |
 28 mm |
 320 N

EMPFEHLUNGEN RECOMMENDATIONS



AF 294 K40 P



North 1 Alu-Mechanik P



Threesixty