

S 235 286 132 K 95 C X

ID 201675

Technisches Datenblatt
Technical data sheet



Spezifikationen Specifications

ID ID	201675	Farbe Colour	chrom	Gesamthöhe Höchste Total height Highest p	418 mm	Drehbar Rotatable	1
Matchcode Matchcode	S235286132K95CX	Gesamthöhe niedrigs Total height lowest po	286 mm	Standrohrlänge Standpipe length	235 mm		
Bezeichnung 1 Designation 1	S 235 286 132 K 95	Hub Stroke	132 mm	Standrohrdurchmess Standpipe diameter	50 mm		
Artikelgruppe Article group	Standard Line Chro	Gewichtsgrenze Weight limit	140 kg	Aufbauhöhe ab Fuß M Build-up height from	192 mm		
Basismengeneinheit Base quantityunit	Stk	Klasse Class	4	Aufbauhöhe ab Fuß M Installation height fro	325 mm		
Menge Karton Quantity carton	20	Durchmesser Gaseinl Diameter gas unit	28 mm	Material	Stahlblech		
Menge Palette Quantity pallet	600	Konuslänge Gaseinhe Cone length gas unit	33 mm	Druck Pressure	320 N		
Gewicht Weight	1.16 kg	Konuslänge Cone length	98 mm	Höhenverstellbar Heightadjustable	1		

S 235 286 132 K 95 C X

ID 201675

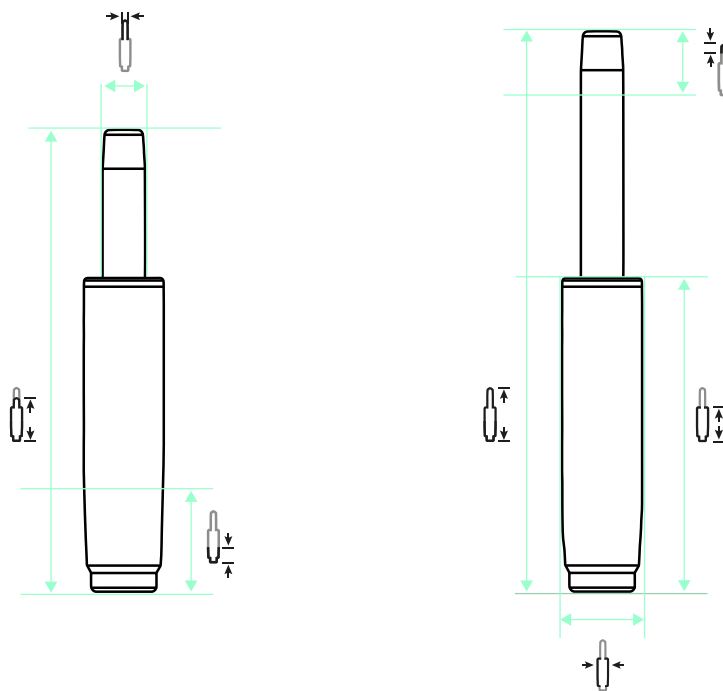

 132 mm |
  418 mm |
  286 mm |
  235 mm |
  98 mm |
  33 mm |
  50 mm |
  28 mm |
  320 N

ZUBEHÖR ACCESSORIES



AD 38 / 50



AD 40 / 50



ÜS-Rohr 183



ÜS-Rohr 244



ÜS-Rohr 298

EMPFEHLUNGEN RECOMMENDATIONS



STELLAR 690 Middle 5 P



STELLAR 690 Middle 5 S



North 1 Alu-Mechanik P



Threesixty