

ND 305 373 192 K 70 S X

ID 201877

Technisches Datenblatt
Technical data sheet



Spezifikationen Specifications

ID ID	201877	Farbe Colour	schwarz	Gesamthöhe Höchst Total height Highest	565 mm	Höhenverstellbar Heightadjustable	1
Matchcode Matchcode	ND305373192K70	Gesamthöhe niedrig Total height lowest possible	373 mm	Standrohrlänge Standpipe length	305 mm		
Bezeichnung 1 Designation 1	ND 305 373 192 K	Hub Stroke	192 mm	Standrohrdurchmesser Standpipe diameter	50 mm		
Artikelgruppe Article group	Non Rotating	Gewichtsgrenze Weight limit	140 kg	Aufbauhöhe ab Fuß Build-up height from base	303 mm		
Basismengeneinheit Base quantity unit	Stk	Klasse Class	4	Aufbauhöhe ab Fuß Installation height from base	495 mm		
Menge Karton Quantity carton	10	Durchmesser Gaseinleitungsrohr Diameter gas inlet pipe	28 mm	Material Material	Stahlblech		
Menge Palette Quantity pallet	420	Konuslänge Gaseinleitungsrohr Cone length gas inlet pipe	33 mm	Druck Pressure	320 N		
Gewicht Weight	1.774 kg	Konuslänge Cone length	70 mm	Anschraubbild Bolting pattern	-		

ND 305 373 192 K 70 S X

ID 201877

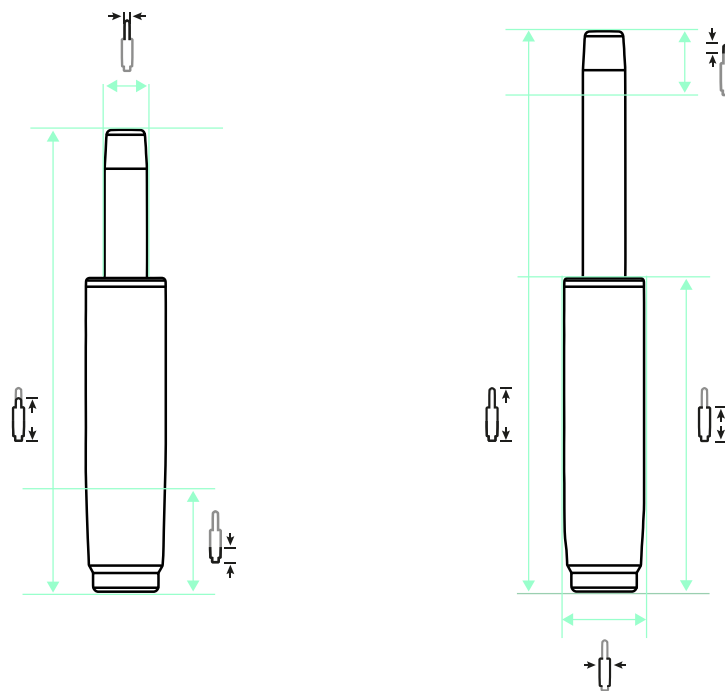

192 mm |
 565 mm |
 373 mm |
 305 mm |
 70 mm |
 33 mm |
 50 mm |
 28 mm |
 320 N

ZUBEHÖR ACCESSORIES



AD 38 / 50



AD 40 / 50



ÜS-Rohr 183



ÜS-Rohr 244



ÜS-Rohr 298

EMPFEHLUNGEN RECOMMENDATIONS



STELLAR 690 Middle 5 P



STELLAR 690 Middle 5 S



North 1 Alu-Mechanik P



Threesixty