

S 455 515 261 K 70 C X

ID 201973

Technisches Datenblatt
Technical data sheet



Spezifikationen Specifications

ID ID	201973	Farbe Colour	chrom	Gesamthöhe Höchste Total height Highest p	776 mm	Drehbar Rotatable	1
Matchcode Matchcode	S455515261K70CX	Gesamthöhe niedrigs Total height lowest po	515 mm	Standrohrlänge Standpipe length	455 mm		
Bezeichnung 1 Designation 1	S 455 515 261 K 70	Hub Stroke	261 mm	Standrohrdurchmess Standpipe diameter	50 mm		
Artikelgruppe Article group	Standard Line Chro	Gewichtsgrenze Weight limit	140 kg	Aufbauhöhe ab Fuß M Build-up height from	445 mm		
Basismengeneinheit Base quantityunit	Stk	Klasse Class	4	Aufbauhöhe ab Fuß M Installation height fro	706 mm		
Menge Karton Quantity carton	10	Durchmesser Gaseinl Diameter gas unit	28 mm	Material	Stahlblech		
Menge Palette Quantity pallet	420	Konuslänge Gaseinhe Cone length gas unit	33 mm	Druck Pressure	320 N		
Gewicht Weight	2.13 kg	Konuslänge Cone length	70 mm	Höhenverstellbar Heightadjustable	1		

S 455 515 261 K 70 C X

ID 201973

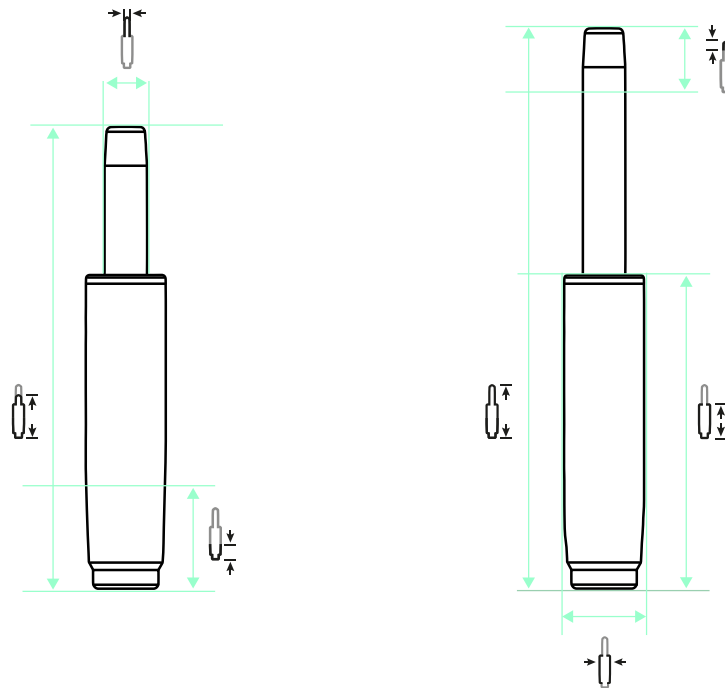

261 mm |
 776 mm |
 515 mm |
 455 mm |
 70 mm |
 33 mm |
 50 mm |
 28 mm |
 320 N

ZUBEHÖR ACCESSORIES



AD 38 / 50



AD 40 / 50



ÜS-Rohr 183



ÜS-Rohr 244



ÜS-Rohr 298

EMPFEHLUNGEN RECOMMENDATIONS



STELLAR 690 Middle 5 P



STELLAR 690 Middle 5 S



North 1 Alu-Mechanik P



Threesixty